

Technical Data
Caractéristiques techniques

LTM 1120/1

Mobile Crane
Grue automotrice

Telescopic boom
Flèche télescopique

184 ft

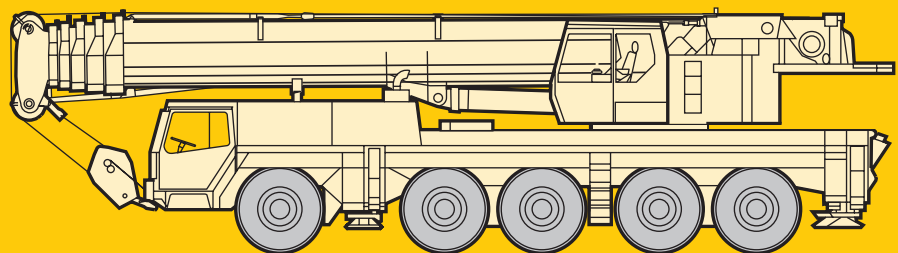

LIEBHERR

Lifting capacities on telescopic boom. Forces de levage à la flèche télescopique.

LTM 1120/1



41 ft – 184 ft



360°

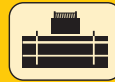

77200 lbs



85%

ft	41 ft		54 ft	68 ft	80 ft	94 ft	107 ft	120 ft	133 ft	146 ft	159 ft	172 ft	184 ft	ft
	1)													
9	300*													9
10	288	243												10
11	268	243												11
12	250	238	221,0											12
13	233	229	215,0											13
14	220	218	205,0	189,0	163,0									14
15	207	207	196,0	181,0	159,0									15
16	196	196	188,0	174,0	153,0									16
17	186	186	181,0	167,0	147,0	122,0								17
18	177	177	173,0	161,0	142,0	121,0								18
20	158	158	157,0	149,0	132,0	117,0	96,0							20
22	143	143	143,0	139,0	123,0	111,0	94,0							22
24	130	130	130,0	128,0	115,0	104,0	90,5	77,0	56,1					24
26	119	119	118,0	116,0	108,0	98,0	86,0	77,0	53,8					26
28	109	109	108,0	106,0	102,0	92,5	82,5	74,5	52,6	48,5				28
30	100	100	99,0	97,0	95,5	87,5	78,5	71,5	51,7	48,2	38,4			30
32	92	92	91,5	89,5	88,5	83,0	75,0	69,0	51,7	48,0	38,3			32
34			85,0	83,0	82,0	78,5	71,5	66,0	51,7	47,4	38,2	35,9	30,2	34
36			79,5	77,5	76,5	73,5	68,5	63,5	51,7	46,7	38,1	35,6	29,6	36
38			73,5	71,5	72,5	68,5	65,5	61,0	51,7	45,9	38,0	35,3	29,1	38
40			69,5	66,5	69,0	64,0	62,5	58,7	51,2	44,9	37,8	34,8	28,5	40
45			61,5		58,8	53,9	53,1	53,3	46,8	41,4	36,6	32,6	27,1	45
50					50,6	46,0	48,2	47,2	42,8	38,1	34,3	30,5	25,7	50
55					43,9	39,7	43,4	41,5	39,1	35,1	31,8	28,5	24,3	55
60					38,3	36,4	38,3	37,6	35,4	32,3	29,4	26,6	23,0	60
65					33,4	33,7	34,0	33,4	31,3	29,8	27,3	24,9	21,7	65
70					29,4	31,4	30,4	29,9	28,0	27,3	25,3	23,4	20,6	70
75						28,8	27,9	26,9	25,0	24,7	23,5	21,9	19,5	75
80						25,9	25,1	24,2	22,4	22,2	21,8	20,6	18,4	80
85						23,3	22,5	21,6	20,1	20,0	20,3	19,4	17,4	85
90							20,3	19,9	17,9	17,8	18,4	18,3	16,5	90
95							18,4	18,3	16,6	15,9	16,5	17,2	15,7	95
100								16,6	15,6	14,3	15,5	15,8	14,9	100
105								15,1	14,6	13,5	14,6	14,2	14,0	105
110								13,8	13,8	12,7	13,6	12,8	12,7	110
115									12,8	12,0	12,5	11,6	11,4	115
120									12,0	11,4	11,4	10,4	10,2	120
125										10,8	10,4	9,3	9,2	125
130										10,3	9,4	8,5	8,3	130
135										9,6	8,7	7,7	7,6	135
140											8,0	7,0	6,9	140
145											7,4	6,4	6,2	145
150											7,0	5,8	5,6	150
155												5,3	5,1	155
160												4,7	4,6	160
165													4,1	165
170													3,6	170
175													3,1	175
	I	0	0/ 0	46/ 0	92/ 0/ 0	92/ 0	92/46/ 0	92/46/ 0	92/ 0/ 0	92/ 0	92/46	92	100	I
	II	0	46/ 0	46/ 0	46/92/ 0	92/46	92/46/92	46/92/92	92/92/46	92/92	92/92	92	100	II
	III	0	0/ 0	0/ 0	0/46/46	0/46	46/46/46	46/46/92	46/92/92	92/92	92/92	92	100	III
	IV	0	0/ 0	0/46	0/ 0/46	0/46	0/46/46	46/46/46	46/92/92	46/92	92/92	92	100	IV
	V	0	0/46	0/46	0/ 0/46	0/46	0/46/46	46/46/46	46/46/92	46/92	46/92	92	100	V

¹⁾ over rear / en arrière

* with special equipment / avec équipement supplémentaire

TAB 110158 / 110159

**Lifting capacities are given
in kips (1,000 lbs).**



Lifting capacities on telescopic boom. Forces de levage à la flèche télescopique.

LTM 1120/1



41 ft - 184 ft





360°



55100 lbs

85%

 ft	41 ft	54 ft	68 ft	80 ft	94 ft	107 ft	120 ft	133 ft	146 ft	159 ft	172 ft	184 ft	 ft
10	242												10
11	230												11
12	218	201											12
13	206	195											13
14	194	187	172	149									14
15	183	178	164	145									15
16	171	170	158	139									16
17	162	161	152	134	111								17
18	153	152	146	129	110								18
20	136	136	134	120	107	87.5							20
22	122	122	120	112	101	85.5							22
24	110	110	108	104	94.5	82.5	70	51					24
26	99.5	99	97	95	89	78.5	70	48.9					26
28	91	90.5	88.5	85.5	81.5	75	67.5	47.8	44.1				28
30	83.5	82.5	80.5	80	73.5	70.5	65	47	43.8	34.9			30
32	77	76	74.5	73.5	67	65	62.5	47	43.6	34.8			32
34		70	68.5	68	61.5	60	59.4	47	43.1	34.7	32.6	27.5	34
36		65.5	63	63	57	57	55.7	47	42.4	34.6	32.4	26.9	36
38		61.5	57.2	57.9	52.3	54.4	52.1	47	41.7	34.5	32.1	26.4	38
40		57.4	52.1	53.3	48.1	51.7	49	46.2	40.8	34.3	31.7	25.9	40
45		47	44.2	44.3	43.4	43.8	42.5	39.8	37.6	33.3	29.7	24.6	45
50			39.2	36.9	38.9	37.8	36.8	34.3	33.3	31.1	27.8	23.3	50
55			34.1	33	34.2	33.4	32	29.7	29.1	28.5	25.9	22.1	55
60				29.7	29.3	29	28	25.8	25.4	25.6	24.2	20.9	60
65				25.8	26	25.1	25.4	23.2	22.2	22.5	22.6	19.8	65
70				23.4	23.1	22	22.5	21.5	19.7	20.7	20.5	18.7	70
75					20.4	19.4	19.8	19.8	18.3	19.3	18.3	17.5	75
80					18.2	17.7	17.5	18.1	17	17.7	16.4	16	80
85					16.2	16.6	15.5	16.2	15.8	15.6	14.7	14.3	85
90						15.1	13.7	15.2	14.6	13.9	13	12.8	90
95						14.2	12.9	14.1	13.2	12.3	11.4	11.3	95
100							12.2	12.9	11.8	10.9	10	9.9	100
105							11.5	11.7	10.5	9.6	8.8	8.7	105
110							10.7	10.6	9.5	8.7	7.9	7.7	110
115								9.6	8.6	7.8	7	6.8	115
120								8.7	7.8	7	6.2	6	120
125									7.1	6.3	5.5	5.3	125
130									6.4	5.7	4.8	4.7	130
135									5.7	5.1	4.2	4.1	135
140										4.5	3.6	3.5	140
145										4	3	3	145
150										3.4	2.5	2.5	150
I	0	0/ 0	46/ 0	92/ 0/ 0	92/ 0	92/46/ 0	92/46/ 0	92/ 0/ 0	92/ 0	92/46	92	100	I
II	0	46/ 0	46/ 0	46/92/ 0	92/46	92/46/92	46/92/92	92/92/46	92/92	92/92	92	100	II
III	0	0/ 0	0/ 0	0/46/46	0/46	46/46/46	46/46/92	46/92/92	92/92	92/92	92	100	III
IV	0	0/ 0	0/46	0/ 0/46	0/46	0/46/46	46/46/46	46/92/92	46/92	92/92	92	100	IV
V	0	0/46	0/46	0/ 0/46	0/46	0/46/46	46/46/46	46/46/92	46/92	46/92	92	100	V

TAB 110099

Les forces de levage sont données en kips (1,000 lbs).

Lifting capacities on telescopic boom. Forces de levage à la flèche télescopique.

LTM 1120/1



41 ft - 184 ft





360°



33100 lbs

85%

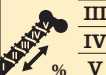
 ft	41 ft	54 ft	68 ft	80 ft	94 ft	107 ft	120 ft	133 ft	146 ft	159 ft	172 ft	184 ft	 ft	
10	241												10	
11	228												11	
12	214	201											12	
13	199	195											13	
14	186	184	172	149									14	
15	173	173	164	145									15	
16	162	162	158	139									16	
17	153	152	149	132	110								17	
18	144	143	139	124	108								18	
20	126	125	120	109	101	87							20	
22	113	112	103	96.5	88	81							22	
24	101	99	89	86.5	77	74.5	68.5	51					24	
26	91	87	78	76.5	68	70	66	48.9					26	
28	81	79	69	68.5	64	64	61	47.8	44.1				28	
30	71	74	61	61.5	60.5	58	55.7	46.8	43.8	34.9			30	
32	62.5	66.5	58.1	55.7	56.8	53.8	51	46	43.6	34.8			32	
34		59.8	54.9	50.9	52.9	49.9	47.1	43.7	41.8	34.6	32.6	27.5	34	
36		54.3	51.6	48.5	49	46.2	43.7	40.5	39	34.3	32.4	26.9	36	
38		48.7	48.2	46.2	45.1	42.6	41	38	36.1	34.1	32.1	26.4	38	
40		43.9	44.9	43.8	41.6	39.3	38.4	36.3	33.5	33.2	31.5	25.9	40	
45		35.5	36.4	36.6	35.7	33	32.4	32	29.8	29.8	28	24.6	45	
50			30.5	31.7	30.7	28.6	27.7	27.7	27	26.2	24.3	22.8	50	
55			26	27.7	26.1	25.8	23.8	24.8	24	22.6	21	20.5	55	
60				23.7	22.2	23	21.4	22.6	21	19.7	18.1	17.7	60	
65				20.6	19.9	21.1	19.7	19.9	18.4	17.2	15.8	15.4	65	
70				18.1	18	18.7	17.9	17.5	16.2	15.1	13.7	13.4	70	
75					16	16.5	15.9	15.4	14.1	13.1	12	11.7	75	
80					14.1	14.6	13.9	13.4	12.2	11.2	10.3	10.1	80	
85					12.5	13	12.2	11.7	10.5	9.6	8.8	8.6	85	
90						11.5	10.8	10.3	9.2	8.3	7.6	7.4	90	
95						10.3	9.6	9.1	8.1	7.3	6.5	6.3	95	
100							8.5	8.1	7.1	6.3	5.5	5.3	100	
105							7.6	7.2	6.2	5.4	4.6	4.5	105	
110							6.7	6.5	5.4	4.7	3.9	3.7	110	
115								5.7	4.8	4	3.2	3	115	
120								5	4.1	3.4			120	
125									3.6	2.8			125	
130									3	2.4			130	
135									2.5				135	
 %	I	0	0/0	46/0	92/0/0	92/0	92/46/0	92/46/0	92/0/0	92/0	92/46	92	100	I
	II	0	46/0	46/0	46/92/0	92/0	92/46/92	46/92/92	92/92/46	92/92	92/92	92	100	II
	III	0	0/0	0/0	0/46/46	0/92	46/46/46	46/46/92	46/92/92	92/92	92/92	92	100	III
	IV	0	0/0	0/46	0/0/46	0/46	0/46/46	46/46/46	46/92/92	46/92	92/92	92	100	IV
	V	0	0/46	0/46	0/0/46	0/46	0/46/46	46/46/46	46/46/92	46/92	46/92	92	100	V

TAB 110100

Lifting capacities on telescopic boom. Forces de levage à la flèche télescopique.

LTM 1120/1



41 ft - 184 ft





360°



15400 lbs

85%

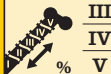
 ft	41 ft	54 ft	68 ft	80 ft	94 ft	107 ft	120 ft	133 ft	146 ft	159 ft	172 ft	184 ft	 ft	
10	240												10	
11	223												11	
12	207	199											12	
13	191	189											13	
14	177	177	166	143									14	
15	165	164	151	133									15	
16	153	152	135	119									16	
17	143	140	122	108	98.5								17	
18	134	128	111	99	90.5								18	
20	116	104	90.5	87	79.5	77.5							20	
22	98.5	90	77.5	75	73	68.5							22	
24	84.5	81.5	71.5	66.5	66	61	58.2	50.7					24	
26	72.5	71	66.5	62.5	58.5	54.4	52.1	49.5					26	
28	62.5	63	59.8	56.6	53.1	49	47.2	45.7	40.3				28	
30	53.7	56.1	53.4	50.8	48.5	44.3	42.7	41.8	38.6	34.5			30	
32	46.9	50.4	48.3	47	44.2	42.1	39	38.3	36.9	34.1			32	
34		45.4	44.1	44.2	40.5	39.5	35.8	36.1	34.8	32.6	30.2	27	34	
36		41	40.9	41.1	37.4	36.7	34.1	33.9	32.3	30.3	28	25.7	36	
38		36.6	37.7	38.1	34.3	35	32.6	31.8	29.9	27.9	25.8	24.4	38	
40		32.7	34.6	35.3	32.2	33.1	30.9	29.8	27.6	25.8	23.8	23	40	
45		26	27.7	29.3	28	27.9	26.2	25.1	23.2	21.6	19.8	19.2	45	
50			22.7	24.4	24.1	23.8	22.4	21.4	19.7	18.3	16.6	16.1	50	
55			18.8	20.4	20.4	20.5	19.2	18.3	16.7	15.5	13.9	13.5	55	
60				17.3	17.3	17.6	16.4	15.7	14.2	13.1	11.7	11.3	60	
65				14.7	14.8	15	14.1	13.5	12.1	11	9.7	9.5	65	
70				12.6	12.6	12.9	12	11.5	10.1	9.2	8.1	7.9	70	
75					10.8	11	10.2	9.7	8.5	7.6	6.7	6.5	75	
80					9.3	9.5	8.7	8.2	7.1	6.3	5.5	5.3	80	
85					7.9	8.3	7.5	7.1	6	5.2	4.3	4.2	85	
90						7.2	6.5	6.1	5	4.2			90	
95						6.3	5.6	5.2	4.2				95	
100							4.8	4.4					100	
105							4	3.8					105	
110							3.4	3.1					110	
 %	I	0	0/ 0	46/ 0	92/ 0/ 0	92/ 0	92/46/ 0	92/46/ 0	92/ 0/ 0	92/ 0	92/46	92	100	I
	II	0	46/ 0	46/ 0	46/92/ 0	92/ 0	92/46/92	46/92/92	92/92/46	92/92	92/92	92	100	II
	III	0	0/ 0	0/ 0	0/46/46	0/92	46/46/46	46/46/92	46/92/92	92/92	92/92	92	100	III
	IV	0	0/ 0	0/46	0/ 0/46	0/46	0/46/46	46/46/46	46/92/92	46/92	92/92	92	100	IV
	V	0	0/46	0/46	0/ 0/46	0/46	0/46/46	46/46/46	46/46/92	46/92	46/92	92	100	V

TAB 110101

Lifting capacities on telescopic boom. Forces de levage à la flèche télescopique.



41 ft – 184 ft



360°



0 lbs



85%

ft	41 ft	54 ft	68 ft	80 ft	94 ft	107 ft	120 ft	133 ft	146 ft	159 ft	172 ft	184 ft	ft	
10	235												10	
11	217												11	
12	200	197											12	
13	184	183											13	
14	170	164	140	119									14	
15	157	145	121	105									15	
16	145	127	107	98									16	
17	132	113	96	90	86								17	
18	119	102	87	82.5	80								18	
20	93	88.5	80.5	74.5	68.5	62.5							20	
22	78	75.5	69.5	65	60.5	55.4							22	
24	65.5	64.5	60.5	57.6	53.5	50.8	45.7	44.9					24	
26	56.1	55.7	53.6	52.6	47	47.2	43.3	41.5					26	
28	48.4	49.2	48.1	47.5	43.2	43.1	39.9	37.9	34.9				28	
30	41.5	43.5	42.8	42.5	40.3	39	36.4	34.4	31.6	29.3			30	
32	36	38.9	38.5	38.6	36.6	35.6	33.2	31.4	28.9	26.8			32	
34		35	35	35.3	33.5	32.7	30.6	28.9	26.6	24.6	22.4	21.6	34	
36		31.5	32.1	32.5	30.9	30.2	28.2	26.7	24.5	22.7	20.6	19.9	36	
38		28	29.1	29.6	28.3	27.7	25.9	24.5	22.5	20.8	18.8	18.2	38	
40		24.9	26.4	27.1	25.9	25.5	23.8	22.6	20.6	19	17.2	16.6	40	
45		19.4	21.1	22.3	21.3	21.2	19.7	18.7	17	15.6	13.9	13.4	45	
50			16.9	18.5	17.8	17.8	16.5	15.6	14	12.8	11.3	10.9	50	
55			13.5	15.3	14.8	14.9	13.8	13.1	11.5	10.4	9	8.7	55	
60				12.6	12.2	12.5	11.5	10.9	9.4	8.4	7.1	6.9	60	
65				10.4	10	10.2	9.4	8.8	7.6	6.7	5.6	5.4	65	
70				8.6	8.4	8.6	7.8	7.3	6.2	5.2			70	
75					7.1	7.3	6.5	6.1	4.9				75	
80					5.9	6.1	5.4	4.9					80	
85					4.8	5.2	4.4	4					85	
90						4.3	3.6						90	
95						3.5							95	
%	I	0	0/ 0	46/ 0	92/ 0/ 0	92/ 0	92/46/ 0	92/46/ 0	92/ 0/ 0	92/ 0	92/46	92	100	I
	II	0	46/ 0	46/ 0	46/92/ 0	92/ 0	92/46/92	46/92/92	92/92/46	92/92	92/92	92	100	II
	III	0	0/ 0	0/ 0	0/46/46	0/92	46/46/46	46/46/92	46/92/92	92/92	92/92	92	100	III
	IV	0	0/ 0	0/46	0/ 0/46	0/46	0/46/46	46/46/46	46/92/92	46/92	92/92	92	100	IV
	V	0	0/46	0/46	0/ 0/46	0/46	0/46/46	46/46/46	46/46/92	46/92	46/92	92	100	V

TAB 110103

Remarks referring to load charts.

- The tabulated lifting capacities do not exceed 85% of the tipping load.
- The crane's structural steelwork is in accordance with DIN 15018, part 3. Design and construction of the crane comply with DIN 15018, part 2, and with F.E.M. regulations.
- The 85% overturning limit values take into account wind force 5 = wind speed 20 mph.
- Lifting capacities are given in kips.
- The weight of the hook blocks and hooks must be deducted from the lifting capacities.
- Working radii are measured from the slewing centreline.
- The lifting capacities given for the telescopic boom only apply if the folding jib is taken off.
- Lifting capacities are subject to modifications.
- Lifting capacities above 243 kips only with additional pulley block/special equipment.

Remarques relatives aux tableaux des charges.

- Les forces de levage indiquées ne dépassent pas 85% de la charge de basculement.
- La norme DIN 15018, 3ème partie est appliquée pour les charpentes. La construction de la grue est réalisée conformément à la norme DIN 15018, 2ème partie, et aux règles de la F. E. M.
- A 85% de la charge de basculement, il a été tenu compte d'un vent de force 5 = vitesse de vent 20 mph.
- Les forces de levage sont données en kips.
- Le poids des mouffes et crochets doit être soustrait des charges indiquées.
- Les portées sont calculées à partir de l'axe de rotation.
- Les forces indiquées pour la flèche télescopique s'entendent fléchette dépliée déposée.
- Les forces de levage sont modifiables sans préavis.
- Forces de levage plus de 243 kips seulement avec équipement supplémentaire.

Lifting heights. Hauteurs de levage.

LTM 1120/1

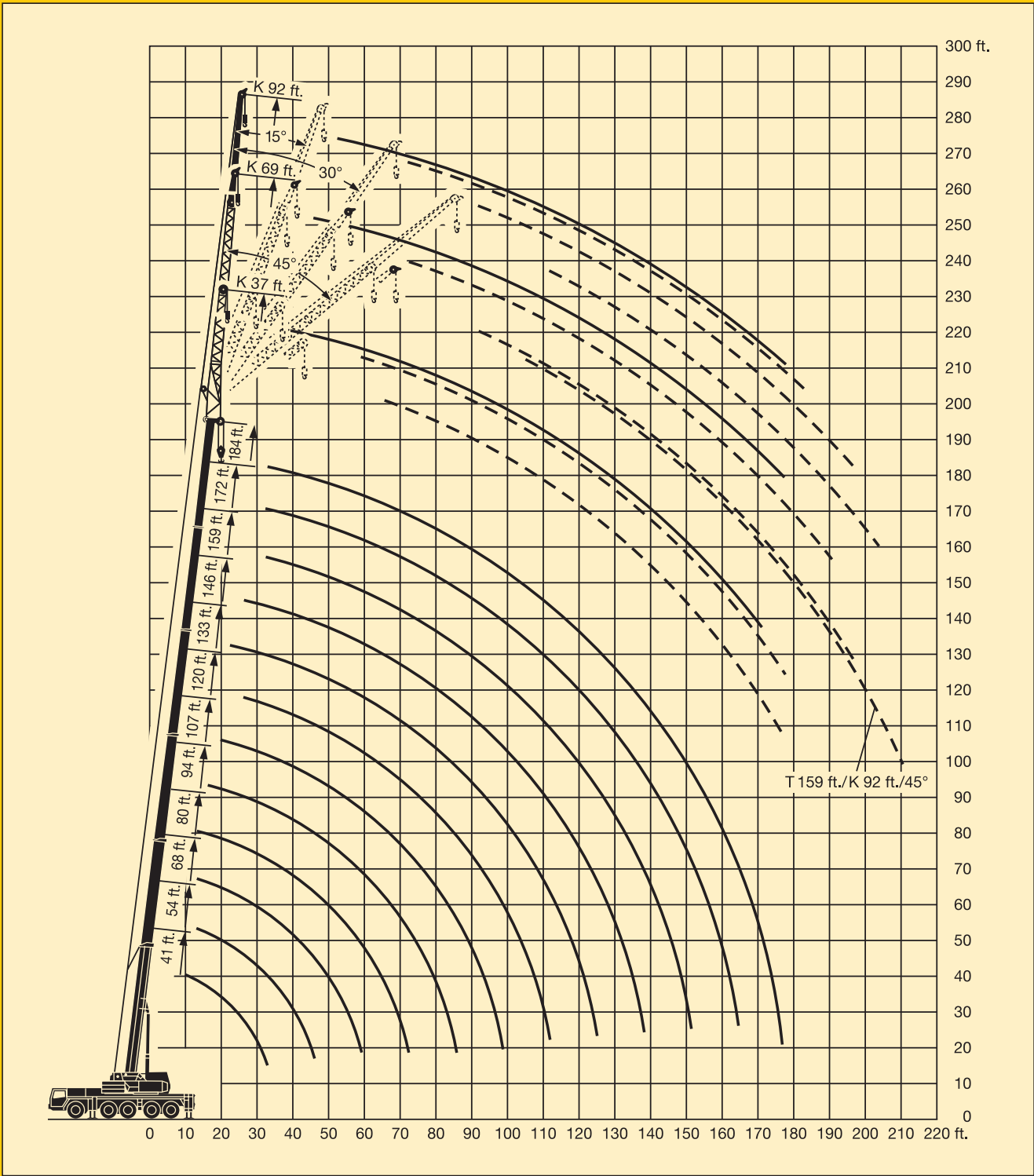

Lifting capacities on the folding jib. Forces de levage à la fléchette pliante.

LTM 1120/1



133 ft – 184 ft

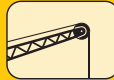

37 ft



360°



77 200 lbs



85%

ft	133 ft				146 ft				159 ft				172 ft				184 ft				ft
	37 ft				37 ft				37 ft				37 ft				37 ft				
	0°	15°	30°	45°	0°	15°	30°	45°	0°	15°	30°	45°	0°	15°	30°	45°	0°	15°	30°	45°	
30	38.1																				30
32	38.1																				32
34	38				32.5																34
36	37.7				32.4																36
38	37.4				32.3																38
40	37	27.9			32	27.2			25.5					20.6						14.3	40
45	35.2	26.4			30.5	25.8			24.5					19.7						14.3	45
50	33.1	25.1	19.4		28.6	24.6			23.2	21.6				18.9	17.8					14.3	50
55	30.9	23.9	18.7	15.9	26.6	23.5	18.7		21.9	20.3	16.3			18.1	16.9	15.6				14.3	55
60	28.8	22.8	18.1	15.7	24.7	22.6	18	15.5	20.5	19.1	16.2	13.1		17.1	16.1	15	12.4	14.1	13.6	12.9	60
65	26.9	21.8	17.4	15.3	23	21.7	17.3	15.2	19.3	18	16.2	13.1	16.1	15.2	14.4	12.4	13.4	12.9	12.2	11.2	65
70	24.9	20.9	16.7	15	21.5	20.6	16.6	14.9	18.1	17	15.6	12.8	15.1	14.3	13.8	12.2	12.7	12.2	11.7	11.2	70
75	23.1	20.1	16	14.3	20	19.4	15.8	14.4	17.1	16.1	14.9	12.3	14.2	13.5	13.1	11.9	12	11.5	11.1	10.8	75
80	21.3	19.4	15.3	13.5	18.7	18.2	15.1	13.6	16	15.2	14.2	11.8	13.4	12.7	12.4	11.5	11.3	10.9	10.6	10.4	80
85	19.2	18.7	14.6	12.6	17.5	17.1	14.4	12.8	15	14.4	13.5	11.3	12.2	12	11.7	11	10.7	10.3	10.1	10	85
90	17.4	18	13.8	11.8	16.5	16.1	13.7	12	14.1	13.6	12.8	10.7	11.9	11.4	11.1	10.6	10.1	9.8	9.6	9.6	90
95	15.7	16.7	13.1	11.1	15.2	15.1	13	11.3	13.2	12.9	12.1	10.1	11.3	10.8	10.6	10.1	9.5	9.3	9.2	9.2	95
100	14.1	15	12.4	10.4	13.8	14.2	12.4	10.6	12.4	12.2	11.5	9.6	10.7	10.3	10.1	9.6	9	8.9	8.8	8.8	100
105	12.6	13.5	11.7	9.7	12.3	13.3	11.8	9.9	11.7	11.6	10.9	9.2	10.1	9.9	9.7	9.2	8.6	8.4	8.4	8.5	105
110	11.1	11.9	11	9.1	10.8	11.7	11.3	9.4	10.9	10.9	10.3	8.8	9.6	9.4	9.3	8.7	8.1	8.1	8.1	8.1	110
115	9.9	10.6	10.4	8.6	9.6	10.4	10.6	8.9	9.9	10.3	9.8	8.5	9.1	9	8.9	8.3	7.8	7.7	7.7	7.7	115
120	8.9	9.4	9.7	8.1	8.7	9.3	9.8	8.4	8.9	9.5	9.3	8.1	8.7	8.7	8.6	7.9	7.4	7.4	7.4	7.4	120
125	8	8.5	8.9	7.7	7.8	8.4	8.8	8	8.1	8.6	8.8	7.8	8.2	8.4	8.2	7.5	7.1	7.1	7.1	7	125
130	7.2	7.7	8	7.4	7	7.5	8	7.6	7.5	7.8	8.2	7.5	7.6	8	7.9	7.1	6.8	6.8	6.8	6.7	130
135	6.6	6.9	7.2	7	6.6	6.8	7.1	7.2	7.1	7.4	7.5	7.3	6.8	7.3	7.5	6.8	6.4	6.5	6.5	6.4	135
140	6.3	6.5	6.5	6.5	6.2	6.5	6.5	6.6	6.7	7	6.8	6.8	6.1	6.6	7	6.5	5.9	6.2	6.2	6.1	140
145	6.1	6.3	6.2	5.7	5.9	6.1	6.2	6	6.3	6.7	6.6	6.2	5.4	5.9	6.3	6.2	5.2	5.7	6	5.9	145
150	5.9	6	5.8	4.8	5.7	5.8	5.9	5.9	5.9	6.3	6.4	5.5	4.8	5.3	5.6	5.8	4.6	5.1	5.4	5.6	150
155	5.6	5.7	5.5	4.3	5.4	5.5	5.6	5.7	5.4	5.7	5.9	5.2	4.3	4.7	5	5.2	4	4.5	4.8	5	155
160					5.2	5.2	5.3	5.5	4.9	5.2	5.4	5	3.7	4.1	4.4	4.5	3.5	3.9	4.2	4.4	160
165					4.9	4.9	5	5.2	4.4	4.6	4.8	4.6	3.3	3.6	3.8	4	3	3.4	3.7	3.8	165
170					4.4	4.6	4.6	4.5	3.8	4.1	4.2	4.2	2.7	3.1	3.3	3.4	2.6	2.9	3.2	3.3	170
175									3.3	3.5	3.7	3.6	2.2	2.5	2.8	2.8	2.1	2.4	2.7	2.8	175
180									2.8	3	3.1										180
I	92/ 0				92/ 0				92/46				92				100				I
II	92/46				92/92				92/92				92				100				II
III	46/92				92/92				92/92				92				100				III
IV	46/92				46/92				92/92				92				100				IV
V	46/92				46/92				46/92				92				100				V

TAB 110168 / 110161 / 110162 / 110163

Lifting capacities on the folding jib. Forces de levage à la fléchette pliante.

LTM 1120/1



133 ft – 184 ft

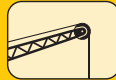

69 ft



360°



77200 lbs

85%

ft	133 ft				146 ft				159 ft				172 ft				184 ft				ft		
	69 ft				69 ft				69 ft				69 ft				69 ft						
	0°	15°	30°	45°	0°	15°	30°	45°	0°	15°	30°	45°	0°	15°	30°	45°	0°	15°	30°	45°			
40	16.8				15.5																	40	
45	16.4				15.2																		45
50	15.9				14.8					13.6							12.1						50
55	15.4	13.2			14.5					13.2							11.6						55
60	14.9	12.7			14.1	12.1				12.8	11.4						11	10.3					60
65	14.4	12.3			13.7	11.8				12.5	11.1						10.6	10					65
70	13.9	11.9	10.2		13.3	11.5				12.1	10.8						10.2	9.7					70
75	13.5	11.5	9.9		12.9	11.1	9.7			11.8	10.6	9.4					9.8	9.3					75
80	13	11.1	9.7	7.2	12.5	10.8	9.5			11.5	10.3	9.2					9.5	9	8.2				80
85	12.6	10.8	9.5	7.1	12.2	10.5	9.4			11	10.1	9.1					9.2	8.7	8				85
90	12.2	10.5	9.3	7.1	11.8	10.3	9.2	6.8		10.5	9.9	9	6.7				8.8	8.4	7.8	6.8			90
95	11.8	10.2	9.1	7	11.5	10	9.1	6.8		10	9.5	8.8	6.6				8.5	8.1	7.7	6.7			95
100	11.5	10	8.9	7	11.1	9.8	8.9	6.8		9.5	9.1	8.7	6.6				8.1	7.9	7.5	6.6			100
105	11.1	9.7	8.7	6.9	10.8	9.6	8.8	6.7		9.1	8.7	8.5	6.6				7.8	7.6	7.3	6.6			105
110	10.8	9.5	8.5	6.8	10.3	9.4	8.6	6.7		8.7	8.4	8.2	6.5				7.5	7.3	7.1	6.5			110
115	10.3	9.3	8.4	6.7	9.8	9.2	8.5	6.7		8.3	8	7.9	6.5				7.2	7	6.9	6.4			115
120	9.7	9.1	8.2	6.6	9.2	9	8.4	6.6		8	7.7	7.6	6.4				6.9	6.7	6.6	6.3			120
125	8.9	9	8.1	6.5	8.5	8.8	8.3	6.5		7.6	7.4	7.3	6.3				6.6	6.4	6.4	6.1			125
130	8.1	8.7	7.9	6.4	7.8	8.4	8.1	6.5		7.3	7.2	7.1	6.2				6.2	6.1	6	5.3			130
135	7.4	8.2	7.8	6.3	7	7.9	7.9	6.4		6.9	6.9	6.8	6.1				6	5.9	5.9	5.9			135
140	6.7	7.5	7.6	6.2	6.4	7.3	7.7	6.3		6.3	6.6	6.6	6				5.8	5.7	5.7	5.7			140
145	6	6.8	7.4	6.1	5.7	6.6	7.3	6.2		5.7	6.4	6.3	5.9				5.5	5.5	5.5	5.5			145
150	5.4	6.2	6.8	5.9	5.1	6	6.6	6.1		5.2	5.9	6.1	5.7				5.2	5.3	5.3	5.4			150
155	4.9	5.6	6.1	5.8	4.6	5.3	6	6		4.9	5.3	5.8	5.6				4.6	5.1	5.1	5.2			155
160	4.3	5	5.5	5.5	4.4	4.8	5.4	5.6		4.7	4.8	5.4	5.4				4.1	4.8	4.9	5			160
165	3.8	4.4	4.8	5.1	4.1	4.3	4.7	5.1		4.5	4.5	4.8	5.2				3.6	4.4	4.7	4.8			165
170	3.7	3.9	4.2	4.3	3.9	4.1	4.2	4.4		4.2	4.3	4.4	4.6				3.1	3.8	4.4	4.6			170
175	3.6	3.7	3.7	3.8	3.7	3.8	3.9	4.1		3.8	4.1	4.2	4.3				2.7	3.4	3.9	4.2			175
180	3.5	3.5	3.5	3.5	3.5	3.6	3.7	4		3.4	3.8	4.1	4.1				2.3	2.9	3.4	3.7			180
185	3.3	3.3	3.3		3.3	3.4	3.5	3.8		2.9	3.4	3.8	3.9					2.5	2.9	3.2			185
190	3.2	3.1	3.1		3.1	3.2	3.3	3.6		2.5	3	3.4	3.5					2.1	2.5	2.7			190
195					2.8	3	3			2.1	2.6	2.9	2.9						2	2.2			195
200					2.5	2.6					2.1	2.4	2.3										200
I		92/ 0				92/ 0					92/46							92				100	I
II		92/46				92/92					92/92							92				100	II
III		46/92				92/92					92/92							92				100	III
IV		46/92				46/92					92/92							92				100	IV
V		46/92				46/92					46/92							92				100	V

TAB 110168/110161/110162/110163

Lifting capacities on the folding jib. Forces de levage à la flèche pliante.

LTM 1120/1



133 ft – 184 ft

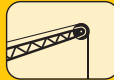

92 ft



159 ft



360°

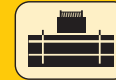

77200 lbs



85%

ft	133 ft				146 ft				159 ft				172 ft				184 ft				ft			
	92 ft				92 ft				92 ft				92 ft				92 ft							
	0°	15°	30°	45°	0°	15°	30°	45°	0°	15°	30°	45°	0°	15°	30°	45°	0°	15°	30°	45°				
40	12.3																				40			
45	12.1																					45		
50	11.9				11				9.8													50		
55	11.7				10.8				9.6					8.6								55		
60	11.5				10.6				9.5					8.4								60		
65	11.2				10.4				9.5					8.1								65		
70	10.9	9.3			10.2	9			9.3					7.9								70		
75	10.6	9			10	8.7			9.1	8.2				7.6	7					3.7		75		
80	10.3	8.7			9.7	8.5			8.9	8				7.4	6.7					3.7		80		
85	10	8.4			9.5	8.2			8.6	7.8				7.1	6.5					3.7		85		
90	9.6	8.1	6.6		9.3	7.9	6.4		8.3	7.6	6.1			6.9	6.3				3.7	3.1		90		
95	9.3	7.9	6.4		9	7.7	6.2		8	7.4	6			6.6	6.1	5.6				3.7	3.1	95		
100	8.9	7.6	6.3	4.7	8.7	7.5	6.1	4.7	7.7	7.2	5.9			6.4	5.9	5.4				3.7	3.1	2.6	100	
105	8.6	7.4	6.1	4.6	8.5	7.3	6	4.6	7.4	7	5.8	4.6		6.1	5.7	5.3	4.3			3.7	3.1	2.6	105	
110	8.3	7.2	5.9	4.5	8.2	7.1	5.8	4.6	7.1	6.8	5.8	4.5		5.9	5.6	5.1	4.2			3.7	3.1	2.6	110	
115	8	6.9	5.8	4.4	7.9	6.9	5.7	4.5	6.8	6.5	5.7	4.4		5.7	5.4	5	4.1			3.7	3.1	2.6	2.4	115
120	7.7	6.7	5.7	4.4	7.7	6.7	5.6	4.4	6.5	6.2	5.6	4.3		5.4	5.2	4.8	4.1			3.7	3.1	2.6	2.4	120
125	7.4	6.6	5.6	4.3	7.4	6.5	5.6	4.4	6.2	6	5.5	4.3		5.2	5	4.7	4.1			3.7	3.1	2.6	2.4	125
130	7.2	6.4	5.5	4.2	7.1	6.3	5.5	4.3	5.9	5.7	5.4	4.2		4.9	4.9	4.6	4.1			3.7	3.1	2.6	2.4	130
135	6.9	6.2	5.4	4.2	6.8	6.2	5.4	4.3	5.7	5.5	5.2	4.1		4.7	4.7	4.4	4			3.7	3.1	2.6	2.4	135
140	6.6	6	5.3	4.2	6.3	6	5.4	4.2	5.4	5.3	5.1	4.1		4.5	4.5	4.3	4			3.6	3.1	2.6	2.4	140
145	6.1	5.8	5.3	4.1	5.7	5.8	5.3	4.2	5.2	5.1	5	4		4.3	4.3	4.2	3.9			3.4	3.1	2.6	2.4	145
150	5.5	5.7	5.2	4.1	5.1	5.7	5.2	4.1	4.9	4.9	4.8	3.9		4.1	4.1	4	3.9			3.2	3.1	2.6	2.4	150
155	4.9	5.5	5.1	4.1	4.6	5.5	5.1	4.1	4.4	4.7	4.6	3.9		3.9	4	3.9	3.8			3.1	3.1	2.6	2.4	155
160	4.4	5.3	5.1	4.1	4	5.1	5.1	4.1	3.9	4.5	4.5	3.9		3.7	3.8	3.7	3.8			2.9	3	2.6	2.4	160
165	3.9	4.8	5	4.1	3.6	4.5	4.9	4	3.4	4.3	4.3	3.8		3.5	3.6	3.6	3.7			2.8	2.8	2.6	2.4	165
170	3.4	4.3	4.9	4.1	3.1	4	4.7	4	3.3	3.9	4.1	3.8		3	3.5	3.4	3.6			2.6	2.7	2.6	2.4	170
175	2.9	3.8	4.4	4.1	2.9	3.5	4.3	4	3.1	3.4	4	3.8		2.6	3.3	3.3	3.5			2.2	2.6	2.6	2.4	175
180	2.6	3.3	3.9	4	2.7	3	3.7	3.9	3	3	3.7	3.7		2.1	3	3.2	3.4				2.4	2.6	2.4	180
185	2.4	2.8	3.4	3.6	2.6	2.7	3.2	3.6	2.7	2.9	3.2	3.6		2.6	3	3.3				2.2	2.4	2.4	2.4	185
190	2.2	2.4	2.8	3	2.4	2.6	2.7	3.1	2.4	2.7	2.8	3.2			2.2	2.9	3.2				1.9	2.3	2.4	190
195	2.1	2.2	2.3	2.4	2.2	2.4	2.5	2.7	2.1	2.6	2.7	2.8				2.5	2.8					2.1	2.2	195
200	2	2	2.1	2.3	2	2.2	2.3	2.6		2.3	2.6	2.7											2.1	200
205	1.9	1.9	1.9		1.9	2	2.1	2.4			2.4	2.5												205
210							1.9																	210
215							1.8																	215
I	92/ 0				92/ 0				92/46				92				100				I			
II	92/46				92/92				92/92				92				100				II			
III	46/92				92/92				92/92				92				100				III			
IV	46/92				46/92				92/92				92				100				IV			
V	46/92				46/92				46/92				92				100				V			

TAB 110168 / 110161 / 110162 / 110163

Dimensions. Encombrement.

LTM 1120/1

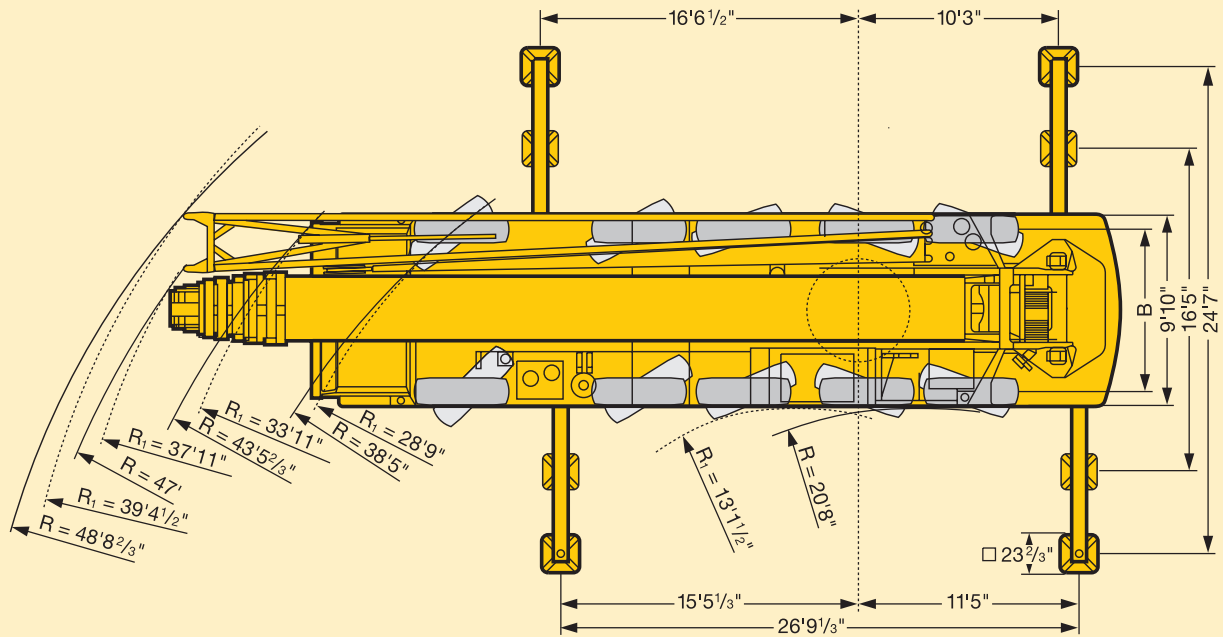
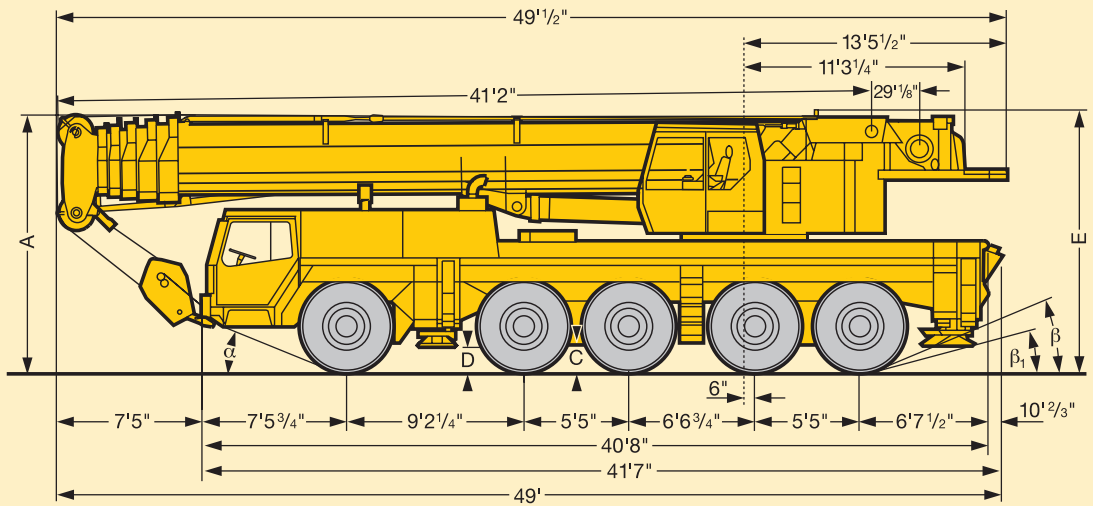

R₁ = All-wheel steering
Direction toutes roues

 16.00 R 25	Dimensions / Encombrement							α	β	β ₁
	A	A 6 ^{11*}	B	C	D	E				
	13'1 1/2"	12'7 1/2"	8'4 3/4"	18 1/2"	14 2/3"	13 3/4"	23°	23°	15°	

* lowered / abaissé

Weights. Poids.

LTM 1120/1



Axle Essieu	1	2	3	4	5	Total weight Poids total
lbs	26500	26500	26500	26500	26500	132500 ¹⁾

¹⁾ with 15400 lbs counterweight / avec contrepoids 15400 lbs









Load (kips) Forces de levage (kips)	No. of sheaves Poulies	No. of lines Brins	Weight lbs Poids lbs
264 ²⁾	9	18	2340
236	7	14	2200
178	5	11	1765
116	3	7	1235
50	1	3	970
17.6	-	1	420





²⁾ on request / sur demande

Working speeds. Vitesses.



	1	2	3	4	5	R	
							
 mp/h	9.3	14.3	22.3	33	47	8	-
 mp/h 	5	8	13	19.3	27.3	4.7	45 %
	16.00 R 25						



Drive Mécanismes	infinitely variable en continu	Rope diameter / Rope length Diamètre du câble / Longueur du câble	Max. single line pull Effort au brin maxi.
	0 - 362 ft/min single line ft/min au brin simple	$\frac{27}{32}'' / 900'$	17400 lbs
	0 - 362 ft/min single line ft/min au brin simple	$\frac{27}{32}'' / 900'$	17400 lbs
	0 - 1.5 rpm		
	approx. 50 seconds to reach 83° boom angle env. 50 s jusqu'à 83°		
	approx. 400 seconds for boom extension from 41 ft - 184 ft env. 400 s pour passer de 41 ft - 184 ft		

Crane carrier.

LTM 1120/1

Frame:	Liebherr designed and manufactured, box type, torsion resistant, all-welded construction made of high-tensile structural steel.
Outriggers:	4-point support, all-hydraulic horizontal and vertical operation.
Engine:	8 cylinder, watercooled Liebherr Diesel, type D 9408 TI-E, 400 kW (544 HP) at 2100 rpm acc. to ECE 24.03 and ECE-R 49.02 (Euro II), max. torque 1640 lbs-ft at 1575 rpm. Fuel tank capacity: 132 gallons.
Transmission:	Allison automatic transmission with torque converter and hydrodynamic retarder brake, 5 forward and 1 reverse speed. Transfer case with off-road range.
Axles:	All axles steered. Axles 1, 4 and 5 with planetary gears and differential locks.
Suspension:	All axles with hydropneumatic suspension and hydraulic locking facility.
Tyres:	10 tyres. Tyre size: 16.00 R 25.
Steering:	Hydraulic power steering with dual circuit hydraulic system, mechanical/hydrostatic from lower cab. Stand-by steering pump. Steering acc. to EC directive 70/311/EEC.
Brakes:	Service brake: Dual circuit, servo-air brake, acting on all wheels. Hand brake: by spring action on all wheels of axles 2 to 5. Brakes acc. to EC directive 71/320/EEC.
Driver's cab:	Spacious all-steel cab on resilient mountings, safety glass windows and full range of instruments.
Electrical system:	24 V DC, 2 batteries, lighting according to countries' regulations.

Crane superstructure.

Frame:	Liebherr-made, torsion-resistant, welded construction made of high-tensile structural steel. Connection to truck chassis by a triple roller slewing ring, designed for 360° continuous rotation.
Crane engine:	4 cylinder, watercooled Liebherr Diesel, type D 924 T-E, 120 kW (163 HP) at 1800 rpm acc. to EPA/CARB and IMO 1 acc. to ISO 8178 C 1, max. torque 529 lbs/ft at 1200 rpm. Fuel tank capacity: 79 gallons.
Crane drive:	Diesel-hydraulic, with 1 duplex axial-piston pump with automatic output control, 1 duplex gear-type pump, open regulated hydraulic circuits. The hydraulic drive in compact construction is directly flanged to the diesel engine.
Crane control:	Load sensing system, 4 working motions can be performed at the same time, by 2 control levers (joy stick type).
Hoist gear:	Axial piston fixed displacement motor, hoist drum with integrated planetary gear and spring loaded static brake.
Luffing gear:	1 differential hydraulic ram with safety check valve.
Slewing gear:	Axial piston fixed displacement motor, planetary gear, spring loaded static brake.
Crane cab:	All-steel construction fully galvanized, safety glazing, heater, controls and instruments.
Safety devices:	LICCON safe load indicator, hoist limit switch, safety valves against rupture of pipe and hoses.
Telescopic boom:	1 base section and 5 telescopic sections, hydraulically extendable under load. All sections extendable independently. Boom length: 41 ft to 184 ft.
Electrical system:	24 V DC, 2 batteries.

Complementary equipment.

Folding jib:	37 ft to 92 ft long, for mounting on telescopic boom at 0°, 15°, 30° or 45°.
2nd hoist gear:	For two-hook operation, or with folding jib in case main hoist shall remain reeved.
Drive 10 x 8:	Axle 2 additionally driven.

Other items of equipment available on request.

Châssis porteur.

LTM 1120/1

Châssis:	Fabrication Liebherr, construction en caisson indéformable, en acier grain fin à haute résistance.
Stabilisateurs:	Calage en 4 points, à télescopage horizontal et vérinage vertical entièrement hydrauliques.
Moteur:	Diesel, Liebherr, type D 9408 TI-E à 8 cylindres, refroidissement par eau, puissance 400 kW (544 CH) à 2100 rpm selon ECE-R 24.03 et ECE-R 49.02 (EURO II), couple maxi. 1640 lbs-ft à 1575 rpm. Capacité réservoir de carburant: 132 gallons.
Boîte:	Boîte automatique, marque Allison, avec convertisseur de couple et frein hydro-dynamique, 5 rapports AV et 1 AR. Boîte transfert avec rapport tout terrain.
Essieux:	Tous essieux directeurs. Essieux 1, 4 et 5 à train planétaire à blocage de différentiel.
Suspension:	Tous les essieux à suspension hydropneumatique et blocables hydrauliquement.
Pneumatiques:	10 pneumatiques. Dimensions des pneumatiques: 16.00 R 25.
Direction:	Direction hydraulique à deux circuits, commande mécanique/hydrostatique depuis la cabine de conduite. Pompe de direction auxiliaire. Direction selon directive CE 70/311/CEE.
Freins:	Frein de service: Servofrein pneumatique à 2 circuits, agissant sur toutes les roues. Frein à main: Par cylindres à ressort, agissant sur les roues des essieux 2 à 5. Freins selon directive CE 71/320/CEE.
Cabine de conduite:	Cabine spacieuse, entièrement en tôle d'acier, à suspension élastique, vitrage de sécurité, éléments de contrôle.
Installation électrique:	24 volts continus, 2 batteries, éclairage conforme au code.

Partie tournante.

Châssis:	Fabrication Liebherr, construction soudée indéformable en acier à grain fin de haute résistance. Couronne d'orientation à triple rangées de rouleaux entre partie tournante et châssis porteur permettant une rotation continue.
Moteur:	Diesel, Liebherr, type D 924 T-E, à 4 cylindres, refroidissement par eau, puissance 120 kW (163 CH) à 1800 rpm selon EPA/CARB et IMO 1 selon ISO 8178 C1, couple maxi. 529 lbs-ft à 1200 rpm. Capacité réservoir de carburant: 79 gallons.
Entraînement de grue:	Diesel-hydraulique, comprenant 1 double pompe à pistons axiaux à régulation de puissance, 1 double pompe à engrenages, circuits hydrauliques ouverts contrôlés. L'entraînement hydraulique en construction compacte, bridé directement au moteur diesel.
Commande:	Load sensing, 4 mouvements simultanés sont possible, par deux manipulateurs (type manche à balai).
Mécan. de levage:	Moteur hydraulique à cylindrée constante, treuil à réducteur planétaire incorporé et frein d'arrêt à ressort.
Mécan. de relevage:	Vérin hydraulique différentiel avec soupape de retenue.
Mécan. d'orientation:	Moteur hydraulique à cylindrée constante, réducteur planétaire, frein d'arrêt à ressort.
Cabine du grutier:	Entièrement en tôle d'acier avec vitrage de sécurité, chauffage, organes de commande et de contrôle.
Dispositifs de sécurité:	Contrôleur de charge LICCON, fin de course de levage, soupapes de sécurité sur tubes et flexibles contre rupture.
Flèche télescopique:	1 élément de base et 5 éléments télescopiques, télescopables hydrauliquement sous charge. Tous les éléments télescopables individuellement. Longueur de flèche: 41 ft à 184 ft.
Installation électrique:	24 volts continus, 2 batteries.

Equipement optionnel.

Fléchette pliante:	37 ft à 92 ft de long, pour montage à la flèche télescopique à 0°, 15°, 30° ou 45°.
2ème mécan. de levage:	Pour le travail avec 2 crochets ou pour le travail avec fléchette pliante lorsque le câble de levage principal reste mouflé.
Entraînement 10 x 8:	2ème essieu est entraîné additionnellement.

Autres équipements supplémentaires sur demande.